

Busbar supports

Single-pole flat-mounted



sb_104.eps

Hexagonal insulators



SB 205-206

sb_117.eps



SB 3

sb_118.eps



SB 2

sb_106.eps

The solution for

- > Electrical distribution



Conformity to standards

- > IEC 61439-1
- > IEC 60865-1



Strong points

- > Insulating materials
- > Durability
- > Adaptability

Function

With SOCOMEC's **insulating bar supports** you can:

- mount and attach the busbars inside the electrical panel,
- cope with the forces experienced by the busbars during a short circuit.

Advantages

Insulating materials

Our range of SB P flat busbar supports with fixed interphase is made from insulating materials. This material poses no risks in terms of clearance and creepage distances.

Durability

Most bar supports have an M8 screw connection which provides outstanding robustness to the entire busbar structure.

Adaptability

The distance between the bar support attachment points is compatible with all commercially available enclosures.

Selection guide

Flat mounting

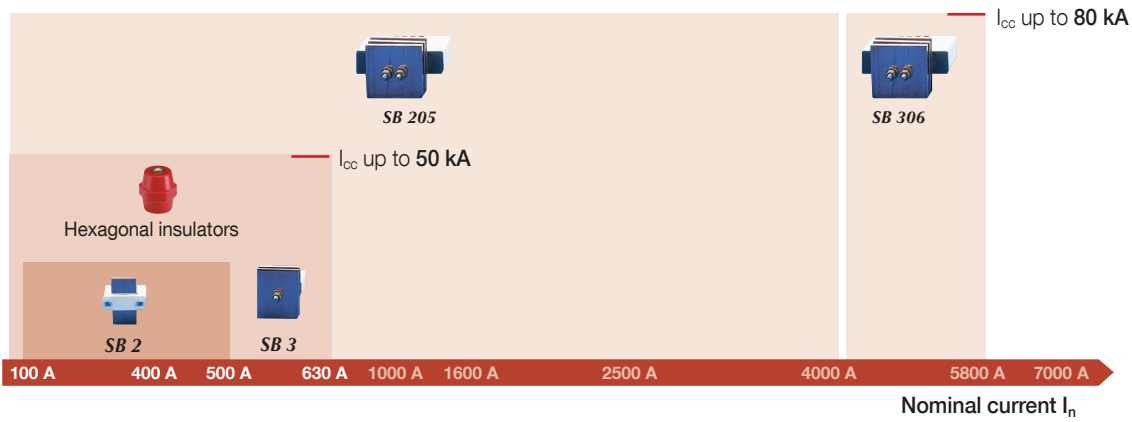

What you need to know

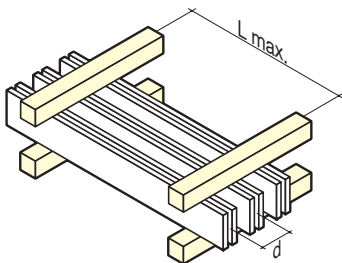

sb_021_ib_1_x_catsps

Adhering to the maximum distance between two supports ensures that the busbar supports are able to withstand the given short circuit current values. At these limits, distortion of the copper bars may occur. These deformations are permitted by standard IEC 61439-1 as long as they adhere to the insulation distances.

Busbar supports

Single-pole flat-mounted

References

Hexagonal insulator

Height H (mm)	Thread M	Available for order in multiples of	Female-female Reference	Male-female Reference	Male-male Reference
16	M4	10	-	5038 1604	5039 1604
16	M5	10	-	5038 1605	5039 1605
20	M4	10	5031 2004	-	-
20	M6	10	5031 2006	-	-
25	M5	10	-	5038 2505	5039 2505
25	M6	10	5031 2506	5038 2506	5039 2506
30	M6	10	5031 3006	-	-
30	M8	10	5031 3008	-	-
35	M6	10	5031 3506	-	-
35	M8	10	5031 3508	5038 3508	5039 3508
35	M10	10	5031 3510	5038 3510	5039 3510
40	M8	10	5031 4008	-	-
40	M10	10	5031 4010	-	-
45	M8	10	5031 4508	-	-
45	M10	10	5031 4510	-	-
50	M8	10	5031 5008	5038 5008	5039 5008
50	M10	10	5031 5010	5038 5010	5039 5010
50	M12	10	5031 5012	-	-
60	M10	10	5031 6010	5038 6010	5039 6010
65	M10	10	5031 6510	-	-
70	M12	10	5031 7012	-	-

SB type support

Support type	Insulation voltage (VAC)	Number of bars	Bar width (mm)	Available for order in multiples of	Reference
SB 2	690	1	32-40	6	5022 0110
SB 3 without screws	690	1 ... 2	32-63	6	5023 0111
SB 3 pre-fitted	690	1 ... 2	32-63	6	5023 0110
SB 205	1000	1 ... 3	100	6	5022 5110
SB 306	1000	1 ... 3	160	6	5023 6110

Accessories

Grub screw

Length (mm)	Thread	To be ordered in multiples of	Reference
20	M6	20	5032 2006
20	M8	20	5032 2008
25	M6	20	5032 2506
25	M8	20	5032 2508
30	M6	20	5032 3006
30	M8	20	5032 3008
40	M8	20	5032 4008
40	M10	20	5032 4010
50	M12	20	5032 5012



sb_121_eps

Characteristics

Hexagonal insulator

Height H (mm)	Thread M	Rated voltage (V) AC/DC	Insulation voltage (VAC)		Mechanical characteristics (daN)		Max. tightening torque (Nm)
			50 Hz 1 min	Peak	Flexion	Traction	
16	M4	500	3000	5500	100	150	3
16	M5	500	3000	5500	100	150	6
20	M4	500	3000	5500	70	170	9
20	M6	500	3000	5500	100	190	8
25	M5	500	3000	5500	180	400	6
25	M6	500	3000	5500	170	370	12
30	M6	1000	6000	11000	200	650	22
30	M8	1000	6000	11000	360	800	40
35	M6	1400	9000	16000	230	720	25
35	M8	1400	9000	16000	380	900	42
35	M10	1400	9000	16000	320	800	44
40	M8	2000	12000	21500	620	1200	50
40	M10	2000	12000	21500	620	1100	60
45	M8	2000	12000	21500	550	1200	55
45	M10	2000	12000	21500	550	1100	65
50	M8	2000	12000	21500	650	1800	60
50	M10	2000	12000	21500	650	1700	70
50	M12	2000	12000	21500	660	1300	130
60	M10	2400	12000	27000	560	1600	85
65	M10	2400	12000	27000	750	1600	90
70	M12	2400	12000	27000	750	1500	135

Busbar supports

Single-pole flat-mounted

Characteristics (continued)

Hexagonal insulator

General characteristics

Height H (mm)	Thread	Bar x qty	L max. (support bars in mm) for					d min. (mm)	Iz (A) ⁽¹⁾	
			peak I _{cc}	24 kA	48 kA	63 kA	82 kA			114 kA
			rms I _{cc}	12 kA	23 kA	30 kA	39 kA			52 kA
20	M4	15 x 5 x 1	400	100				45	220	
20	M4	20 x 5 x 1	400	100				45	280	
25	M6	15 x 5 x 1	550	135				45	220	
25	M6	20 x 5 x 1	525	135				45	280	
25	M6	25 x 5 x 1	575	145				50	330	
30	M6	15 x 5 x 1	675	165				45	220	
30	M6	20 x 5 x 1	650	165				45	280	
30	M6	25 x 5 x 1	725	175	105			50	330	
30	M8	15 x 5 x 1	850	250	155			45	220	
30	M8	20 x 5 x 1	1000	250	155			45	280	
30	M8	25 x 5 x 1	1000	275	170	100		50	330	
35	M6	15 x 5 x 1	700	175	100			45	220	
35	M6	20 x 5 x 1	675	170	100			45	280	
35	M6	25 x 5 x 1	750	175	110			50	330	
35	M8	15 x 5 x 1	850	275	160			45	220	
35	M8	20 x 5 x 1	1000	275	160			45	280	
35	M8	25 x 5 x 1	1000	300	175	105		50	330	
35	M8	32 x 5 x 1	1000	325	175	110		55	410	
35	M10	20 x 5 x 1	850	200	125			45	280	
35	M10	25 x 5 x 1	950	225	135			50	330	
35	M10	32 x 5 x 1	1000	250	150			55	410	
40	M8	20 x 5 x 1	1000	325	175	110		45	280	
40	M8	25 x 5 x 1	1000	350	200	125		50	330	
40	M8	32 x 5 x 1	1000	375	225	135		55	410	
40	M10	20 x 5 x 1	1000	325	175	110		45	280	
40	M10	25 x 5 x 1	1000	350	200	125		50	330	
40	M10	32 x 5 x 1	1000	375	225	135		55	410	
45	M8	25 x 5 x 1	1000	425	250	150		50	330	
45	M8	32 x 5 x 1	1000	475	175	160		55	410	
45	M8	50 x 5 x 1	1000	625	350	200	110	75	600	
45	M10	25 x 5 x 1	1000	425	250	145		50	330	
45	M10	32 x 5 x 1	1000	450	250	160		55	410	
45	M10	50 x 5 x 1	1000	600	350	200	110	75	600	
50	M8	25 x 5 x 1	1000	450	250	155		50	330	
50	M8	32 x 5 x 1	1000	475	275	170		55	410	
50	M8	50 x 5 x 1	1000	650	375	225	115	75	600	
50	M10	32 x 5 x 1	1000	525	300	175		55	410	
50	M10	50 x 5 x 1	1000	700	400	225	125	75	600	
60	M10	50 x 5 x 1	1000	700	400	225	125	75	600	
65	M10	50 x 5 x 1	1000	775	450	250	135	75	600	

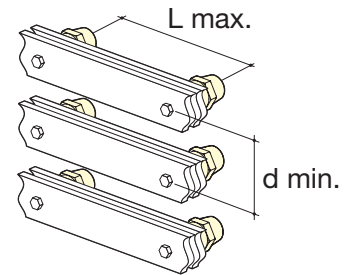

sb_164_a_1_x_cat

(1) Admissible busbar nominal current with a temperature inside the panel of between 45 °C and 80 °C.
For other mounting configurations, please contact us.

SB 1 - SB 2

Support	Bar x qty	L max. (support bars in mm) for					d min. (mm)	Iz (A) ⁽¹⁾	
		peak I _{cc}	24 kA	48 kA	63 kA	82 kA			114 kA
		rms I _{cc}	12 kA	23 kA	30 kA	39 kA			52 kA
SB 1	20 x 3 x 1	650	325	250	175	135	50	210	
SB 1	20 x 5 x 1	850	425	325	250	175	50	280	
SB 1	25 x 5 x 1	1000	525	400	300	200	50	330	
SB 2	32 x 5 x 1	1000	750	575	450	300	70	410	
SB 2	40 x 5 x 1	1000	950	700	550	400	70	500	

(1) Admissible busbar nominal current with a temperature inside the panel of between 45 °C and 80 °C.
For other mounting configurations, please contact us.

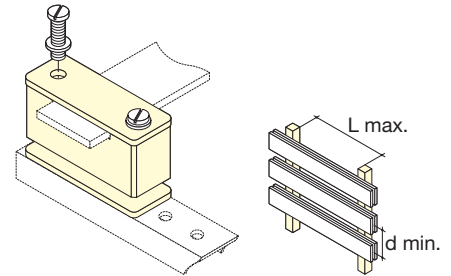

sb_150_a_1_x_cat

SB 3

Support	Bar x qty	L max. (support bars in mm) for					d min. (mm)	Iz (A) ⁽¹⁾	
		peak I _{cc}	24 kA	48 kA	63 kA	82 kA			114 kA
		rms I _{cc}	12 kA	23 kA	30 kA	39 kA			52 kA
	32 x 5 x 2	1000	1000	925	700	500	70	580	
	40 x 5 x 2	1000	1000	1000	1000	1000	70	700	
	50 x 5 x 2	1000	1000	1000	925	675	75	850	
	63 x 5 x 2	1000	1000	1000	1000	1000	85	1000	

(1) Admissible busbar nominal current with a temperature inside the panel of between 45 °C and 80 °C.
For other mounting configurations, please contact us.

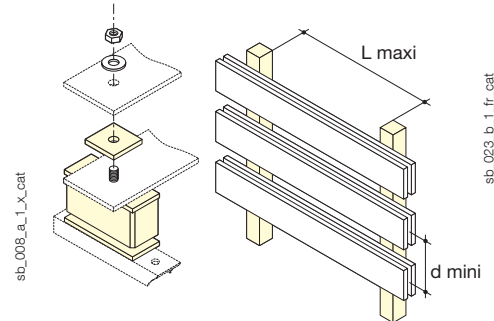

sb_008_a_1_x_cat

sb_023_b_1_fr_cat

SB 205 - SB 206

Support	Bar x qty	L max. (support bars in mm) for						d min. (mm)	Iz (A)	
		peak I _{cc}	48 kA	63 kA	82 kA	114 kA	152 kA			165 kA
		rms I _{cc}	12.5 kA	23 kA	30 kA	40 kA	50 kA			75 kA
SB 205	100 x 10 x 1	1000	800	475	250	150	125	125	1550	
SB 205	100 x 10 x 2	1000	800	475	250	150	125	125	2750	
SB 205	100 x 10 x 3	1000	800	475	250	150	125	125	3850	
SB 306	160 x 10 x 1	1000	1000	625	350	200	150	175	2350	
SB 306	160 x 10 x 2	1000	1000	625	350	200	150	175	4150	
SB 306	160 x 10 x 3	1000	1000	625	350	200	150	175	5800	

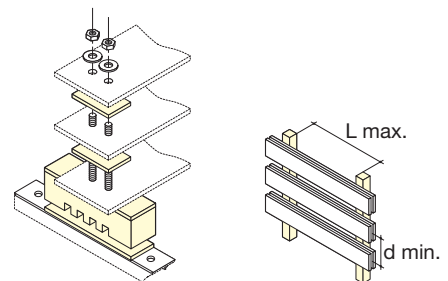

sb_152_a_1_x_cat

Busbar supports

Single-pole flat-mounted

Dimensions

Hexagonal insulator

Height H (mm)	Thread M	Depth		Diameter E (mm)	Length	
		D (mm)	Pu (mm)		W (mm)	L1 (mm)
16	M4	6	5	14	26	36
16	M5	6	5	14	26	36
20	M4	8	5.5	19	-	-
20	M6	8	5.5	19	-	-
25	M5				35	45
25	M6	10	7	25	35	45
30	M6	10	7	33	-	-
30	M8	12	9	33	-	-
35	M6	12	9	33	-	-
35	M8	12	9	33	50	65
35	M10	12	9	33	65	95
40	M8	15	12	40	-	-
40	M10	15	12	40	-	-
45	M8	15	12	41	-	-
45	M10	15	12	41	-	-
50	M8	20	17	46	75	100
50	M10	20	17	46	80	110
50	M12	20	17	46	-	-
60	M10	20	17	50	85	110
65	M10	20	17	55	-	-
70	M12	25	21	55	-	-

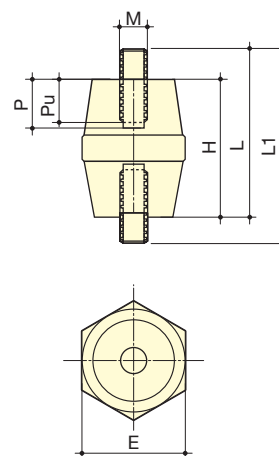

sb_224_a_1_fr_cat.eps

SB 1 – SB 2

Support	A	B	C	J
SB 1	50	23	20	34
SB 2	68	23	23.5	50

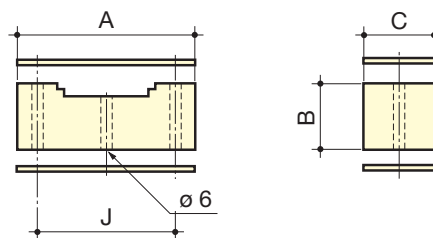

sb_014_c_1_x_cat

SB 3

Support	A	B	C	J
SB 3 without screws	65	32	28	36
SB 3 pre-fitted	65	32	28	36

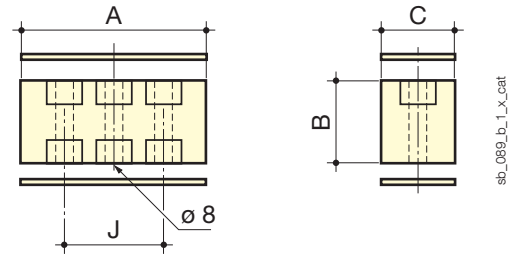

Dimensions

