



ATyS M range

ATyS *d* M, ATyS *t* M, ATyS *g* M, ATyS *p* M
from 40 to 160 A

Accessories

Bridging bars

Use

Used to bridge the outgoing common connection between switch I and switch II. The bridging bar does not reduce the connection capacity of the cage terminals.

Rating (A)	No. of poles	Reference
40 ... 125	2 P	1309 2006
160	2 P	1309 2016
40 ... 125	4 P	1309 4006
160	4 P	1309 4016

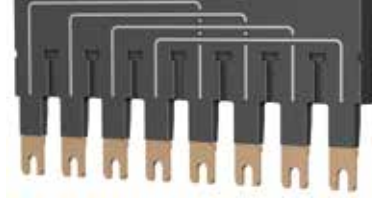

atysm_025.eps

Voltage sensing and power supply tap

Use

It allows connection of $2 \times \leq 1.5 \text{ mm}^2$ voltage sensing or power cables.

The single-pole voltage sensing tap can be mounted in any of the terminals (incoming) without reducing their connecting capacity.

Rating (A)	Pack	Reference
40 ... 160	2 pieces	1399 4006



atysm_026_a.eps

Terminal shrouds

Use

Protection against direct contact with terminals or connecting parts.

Advantages of the terminal shrouds

Perforations allow remote thermographic inspection without the need to remove the shrouds. Possibility of sealing.

Mounting

For complete upstream and downstream protection of 4 pole products, please order quantity 2; for 2 pole products please order quantity 1.

Rating (A)	Position	Reference
40 ... 160	top / bottom	2294 4016⁽¹⁾

(1) Reference composed of 2 pieces.

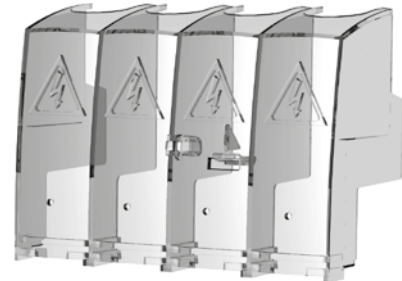

atysm_027_a.eps

Auxiliary contact

Use

A maximum of two auxiliary contact blocks can be fitted to each product. Each auxiliary contact block integrates 3 NO/NC auxiliary contacts (I, O, II).

The ATyS *d* M is delivered as standard with 1 block with separate common points.

Characteristics:

250 VAC / 5 A maximum.

24 VDC / 2 A maximum.

Rating (A)	Type	Reference
40 ... 160	Separate common points	1309 1001
40 ... 160	Linked common points	1309 1011



access_363.eps



access_368.eps

Sealable cover

Use

Prevents access to the ATyS *t* M and ATyS *g* M configuration panels.

Rating (A)	No. of poles	Reference
40 ... 160	2 P	1359 2000
40 ... 160	4 P	1359 0000



atysm_313.eps

Polycarbonate enclosure

Use

Dedicated to the installation of a three-phase ATyS M, it enables easy integration of a compact transfer switch solution.

Rating (A)	H x W x D (mm)	Reference
40 ... 160	385 x 385 x 193	1309 9006



Extension unit

Use

Combined with the polycarbonate enclosure, the extension unit provides additional space in order to connect 70 mm² cables to the ATyS M with ease.

Rating (A)	Reference
40 ... 160	1309 9007



Residential enclosure

Use

Dedicated to the implementation of a single-phase ATyS M, the plastic enclosure provides a compact IP41 transfer switch solution with easy integration.

Rating (A)	H x W x D (mm)	Reference
40 ... 160	410 x 305 x 150	1309 9056



Double power supply - DPS

Use

Allows an ATyS d M to be supplied by two 230 VAC 50/60 Hz networks.

Input

- The input is considered as "active" from 200 VAC.
- Maximum voltage: 288 VAC.
- Internal protection: each input is fuse protected (3.15 A).
- Connection on terminals: max. 6 mm².
- Modular product: the width of 4 modules.

Description of accessories	Reference
DPS	1599 4001

Input 1	Input 2	Output
230 VAC	0 VAC	230 VAC (input 1)
0 VAC	230 VAC	230 VAC (input 2)
230 VAC	230 VAC	230 VAC (input 1)
0 VAC	0 VAC	0 VAC

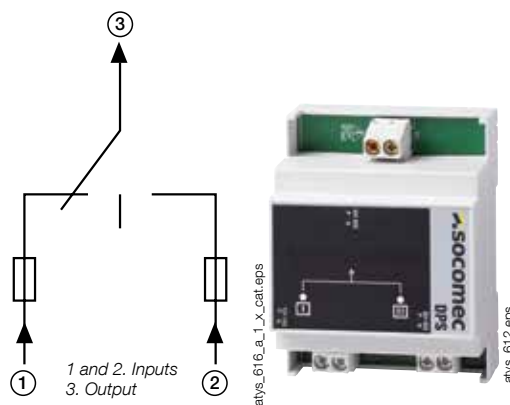

ATyS M range

ATyS d M, ATyS t M, ATyS g M, ATyS p M

from 40 to 160 A

Accessories (continued)

Auto-transformer

Use

For use with ATyS M in 400 VAC three-phase applications that have no distributed neutral. The ATyS M includes integrated sensing and power supply circuits, therefore a neutral connection is required for 400 VAC three-phase applications. When no neutral connection is available this autotransformer (400/230 VAC, 400 VA) provides the 230 VAC required for the ATyS to function.



trafo_165.eps

Rating (A)	Reference
40 ... 160	1599 4121

Remote interfaces for ATyS p M

Use

To remotely display source availability and position indication on the front of a panel when the ATyS M is enclosed.

The remote interface is powered directly from the ATyS M via the RJ45 connection cable. Maximum cable length: 3 m.

D10

To display source availability and position indication on the front panel of an enclosure.

Protection degree: IP21.

D20

In addition to the functions of the D10, the D20 displays measurements and enables control and configuration from the front of the display panel.

Protection degree: IP21.

Door mounting

2 holes \varnothing 22.5.

ATyS M connection via RJ45 cable, not isolated.

Cable not provided.



atys_564.eps



atys_565.eps



atys_597.eps

RJ45 to connect to ATyS p M

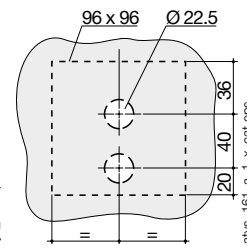

Drillings

atys_161_a_1_x_cat.eps

Description of accessories	Reference
D10	9599 2010
D20	9599 2020

Connecting cable for remote interfaces

Use

To connect between a remote interface (type D10 or D20) and a control product (ATyS p M).

Characteristics:

RJ45 8 wire straight-through, non isolated cable. Length 3 m.



acces_209.eps

Type	Length	Reference
RJ45 cable	3 m	1599 2009

Cage-terminal interface

Use

The power connection terminals allow conversion of the cage clamp terminals into bolt-on type connection terminals, enabling connection of up to two 35 mm² cables or one 70 mm² cable. Compatible with aluminium terminals. Each power connection terminal is provided with separation screens.



atysm_252.psd

Rating (A)	Reference
40 ... 160	1399 4017 ⁽¹⁾

(1) For complete conversion, order quantity 3.

Dimensions

ATyS M 40 to 160 A

Single-phase ATyS M

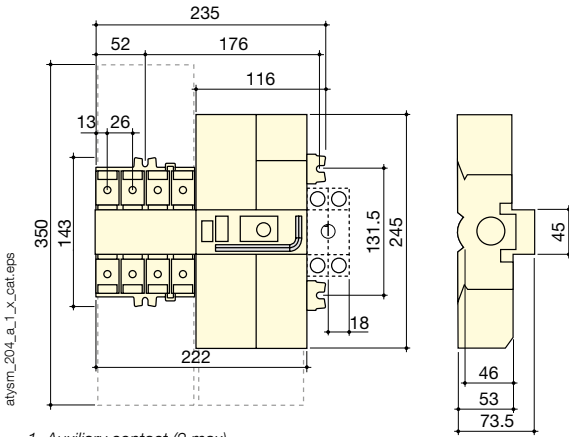

1. Auxiliary contact (2 max).

Three-phase ATyS M

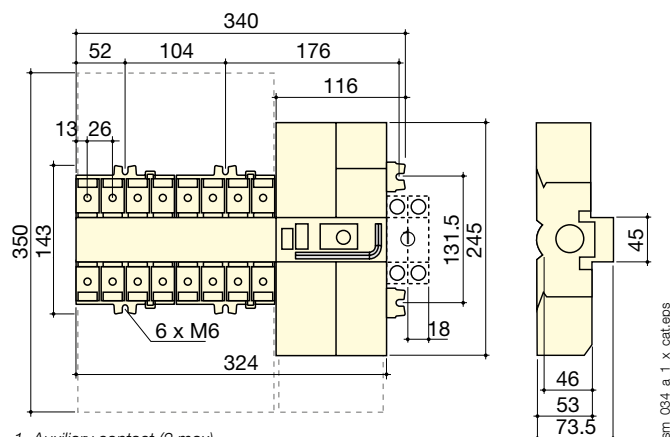

1. Auxiliary contact (2 max).

Single-phase ATyS M - door cut-out

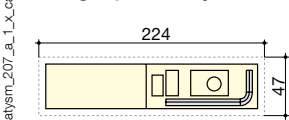

Three-phase ATyS M - door cut-out

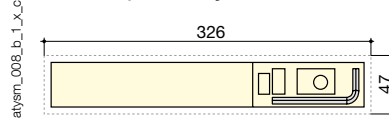

Terminals and connections

Single-phase ATyS d M

Three-phase ATyS d M

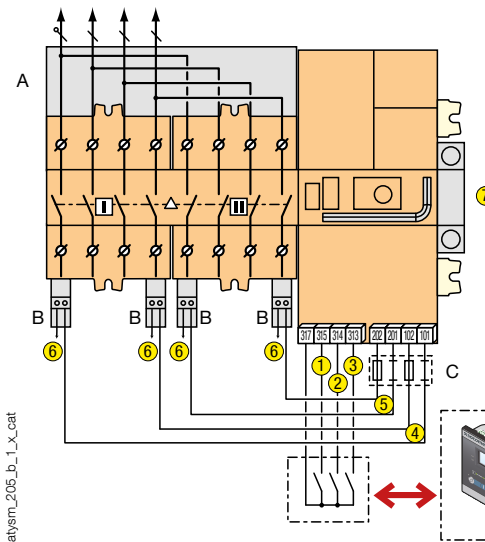
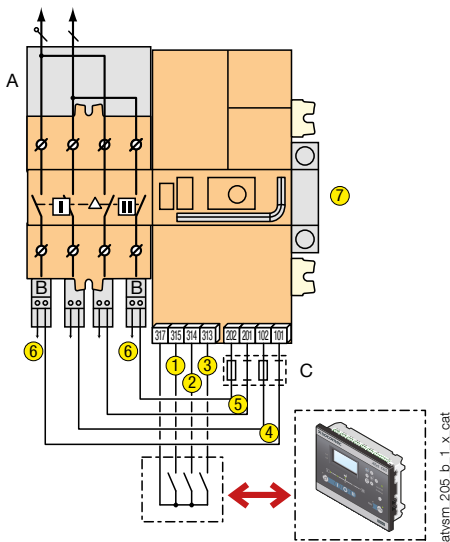

- 1: position I control
- 2: position II control
- 3: position 0 control C
- 4: power supply I (230 VAC)
- 5: power supply II (230 VAC)
- 6: voltage tap
- 7: auxiliary contact block - 1 NO/NC per position I, 0, II (factory fitted)

- A: bridging bar (accessory)
- B: voltage sensing tap (accessory)
- C: F1 / F2 = fuse 10 A gG

ATyS M range

ATyS d M, ATyS t M, ATyS g M, ATyS p M

from 40 to 160 A

Terminals and connections (continued)

Three-phase ATyS t M

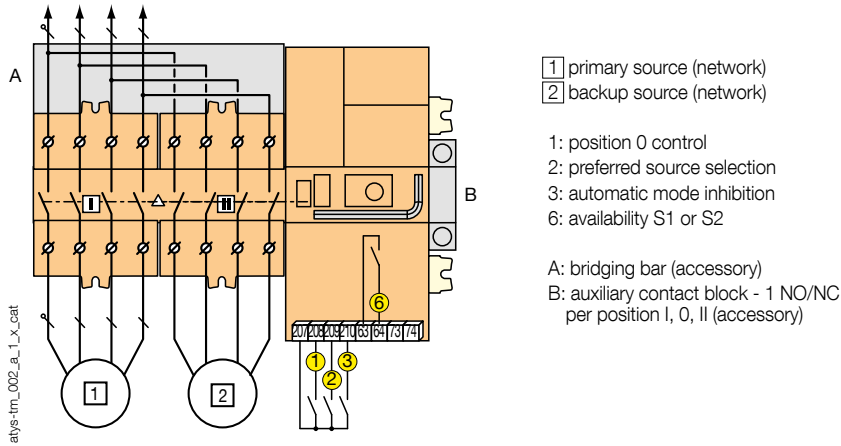

Single-phase ATyS g M

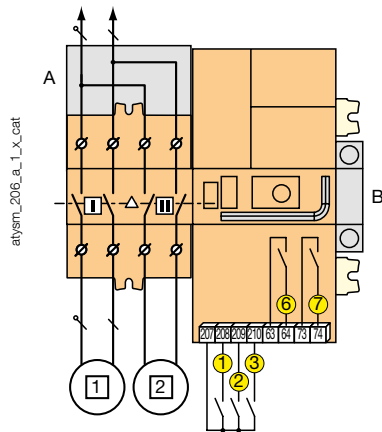

Three-phase ATyS g M

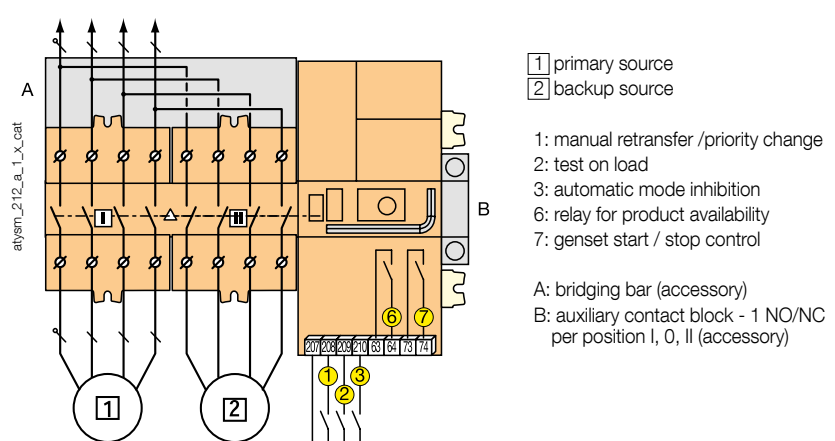

Three-phase ATyS p M

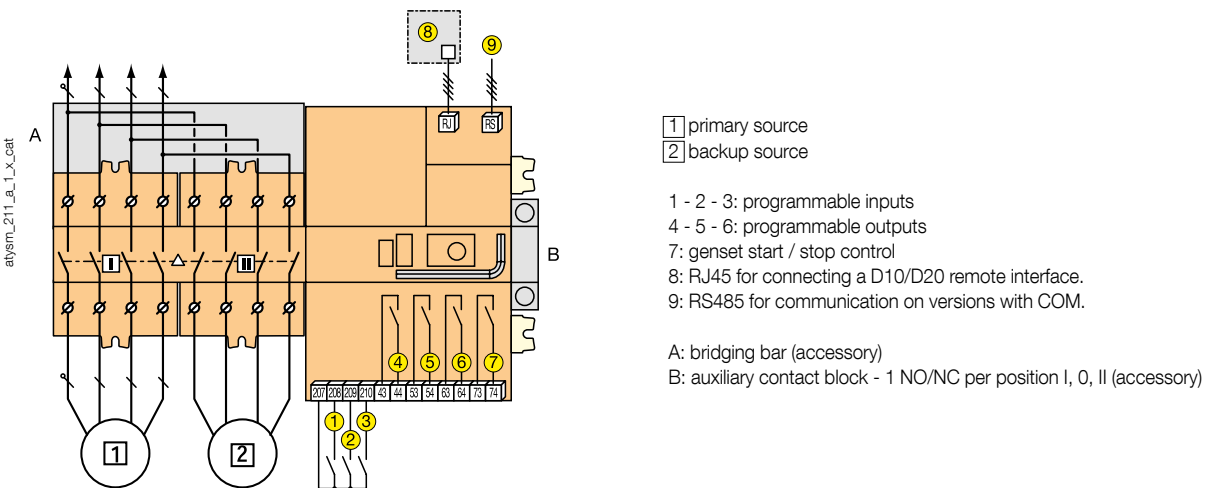

Characteristics according to IEC 60947-3 and IEC 60947-6-1

40 to 160 A

Thermal current I_{th} at 40°C	40 A	63 A	80 A	100 A	125 A	160 A
Rated insulation voltage U_i (V) (power circuit)	800	800	800	800	800	800
Rated impulse withstand voltage U_{imp} (kV) (power circuit)	6	6	6	6	6	6
Rated insulation voltage U_i (V) (control circuit)	300	300	300	300	300	300
Rated impulse withstand voltage U_{imp} (kV) (control circuit) - ATyS d M	4	4	4	4	4	4
Rated impulse withstand voltage U_{imp} (kV) (control circuit) - ATyS t M, g M and p M	2.5	2.5	2.5	2.5	2.5	2.5

Rated operational currents I_e (A) according to IEC 60947-6-1

Rated voltage	Utilisation category	A/B ⁽¹⁾	A/B ⁽¹⁾	A/B ⁽¹⁾	A/B ⁽¹⁾	A/B ⁽¹⁾	A/B ⁽¹⁾
415 VAC	AC-31 A / AC-31 B	40/40	63/63	80/80	100/100	100/125	100/160
415 VAC	AC-32 A / AC-32 B	40/40	63/63	80/80	100/100	100/125	100/160
415 VAC	AC-33 A / AC-33 B	-/40	-/63	-/80	-/100	-/125	-/125

Rated operational currents I_e (A) according to IEC 60947-3

Rated voltage	Utilisation category	A/B ⁽¹⁾	A/B ⁽¹⁾	A/B ⁽¹⁾	A/B ⁽¹⁾	A/B ⁽¹⁾	A/B ⁽¹⁾
415 VAC	AC-20 A / AC-20 B	40/40	63/63	80/80	100/100	125/125	160/160
415 VAC	AC-21 A / AC-21 B	40/40	63/63	80/80	100/100	125/125	160/160
415 VAC	AC-22 A / AC-22 B	40/40	63/63	80/80	100/100	125/125	160/160
415 VAC	AC-23 A / AC-23 B	40/40	63/63	80/80	100/100	125/125	125/160
690 VAC	AC-21 A / AC-21 B	40/40	63/63	80/80	100/100	125/125	160/160
690 VAC	AC-22 A / AC-22 B	40/40	63/63	80/80	80/80	100/125	100/125
690 VAC	AC-23 A / AC-23 B	40/40	63/63	63/63	80/80	80/80	80/80

Current rated as conditional short-circuit with fuse gG DIN

Conditional short-circuit current (kA rms)	50	50	50	50	50	40
Associated fuse rating (A)	40	63	80	100	125	160

Current rated as conditional short-circuit with any brand of circuit breaker that ensures tripping in less than 0.3s⁽⁴⁾

Current rated as short-time withstand low 0.3s (kA rms)	7	7	7	7	7	7
---	---	---	---	---	---	---

Short-circuit operation (switch only)

Current rated as short-time withstand I_{cw} 1s (kA rms) ⁽²⁾	4	4	4	4	4	4
Rated peak withstand current (kA peak) ⁽²⁾	17	17	17	17	17	17

Connection

Minimum connection cross-section (mm ²)	10	10	10	10	10	10
Maximum Cu cable cross-section (mm ²)	70	70	70	70	70	70
Tightening torque (Nm)	5	5	5	5	5	5

Switching time⁽⁵⁾

I - 0 or II - 0, following a command (ms)	45	45	45	45	45	45
Transfer time I - II or II - I, following a command (ms)	180	180	180	180	180	180
I-0 or II-0, after outage (s)	1.2	1.2	1.2	1.2	1.2	1.2
I-II or II-I transfer time, after outage (s)	1.4	1.4	1.4	1.4	1.4	1.4
Contact transfer time ("black-out") I-II min. (ms) ⁽³⁾	150	150	150	150	150	150

Power supply

Min./max. auxiliary power supply (VAC) (ATyS d M, t M and g M)	176/288	176/288	176/288	176/288	176/288	176/288
Min./max. auxiliary power supply (VAC) (ATyS p M)	160/305	160/305	160/305	160/305	160/305	160/305

Control supply power demand

Rated power (VA)	6	6	6	6	6	6
Max. intensity at 230 VAC (A) - ATyS d M, t M and g M	30	30	30	30	30	30
Max. intensity at 230 VAC (A) - ATyS p M	20	20	20	20	20	20

Mechanical specifications

Durability (number of operating cycles)	10,000	10,000	10,000	10,000	10,000	10,000
Weight of single-phase models - non-packaged (kg)	2.8	2.8	2.8	2.8	2.8	2.8
Weight of single-phase models - including packaging (kg)	3.5	3.5	3.5	3.5	3.5	3.5
Weight of three-phase models - non-packaged (kg)	3.5	3.5	3.5	3.5	3.5	3.5
Weight of three-phase models - including packaging (kg)	4.2	4.2	4.2	4.2	4.2	4.2

(1) Category with index A = frequent operation / Category with index B = infrequent operation.

(2) For a rated operational voltage $U_o = 400$ VAC.

(3) 5% tolerance.

(4) Value for coordination with any circuit breaker that ensures tripping in less than 0.3s.

For coordination with specific circuit-breaker references, higher short-circuit current values are available. Please contact us.

(5) At rated voltage - excluding time delays, where applicable.