



DIRIS A-20

Multifunction measuring unit - PMD

measurement and monitoring - door mounting

Single-circuit metering,
measurement &
analysis



DIRIS A-20

diris_061_front.jpg

The solution for

- > Industry
- > Infrastructure
- > Building



Strong points

- > User-friendly operation
- > Compliant with IEC 61557-12
- > Detects wiring errors
- > Customisable

Compliance with standards

- > IEC 61557-12
- > IEC 62053-22 class 0.5S
- > IEC 62053-23 class 2
- > UL



Related software

- > To use Socomec PMDs effectively, we can offer you several dedicated software tools. See "Easy Config System" pages.

Function

DIRIS A-20 units are performance metering and monitoring devices that provide the user with all of the measurements needed to complete energy efficient projects successfully and to provide assured monitoring of electrical distribution.

All of this information can be used and analysed remotely with the help of energy efficiency software programs.

Advantages

User-friendly operation

With its large backlit multiple-display screen with 4 hot keys, the DIRIS A-20 is easy to use.

Compliant with IEC 61557-12

Reference standard for PMDs (Performance metering & monitoring devices), IEC 61557-12 guarantees performance levels and satisfactory performance from the PMDs under the environmental conditions typical of industrial and tertiary applications.

Detects wiring errors

The DIRIS A-20 is equipped with an error correction function for CT connection.

Customisable

Additional communication and input/output modules can extend the basic functional scope of this product. Equipped with additional modules, the DIRIS A-20 can provide the user with flexibility and expandability throughout the service life of the product.

Functional diagram

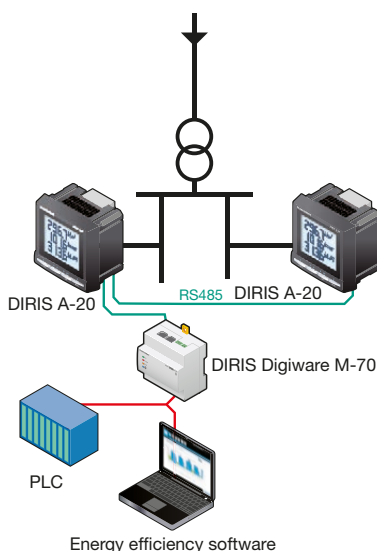

DIRIS_576_L1_en_cat

Functions

Multi-measurement

- Currents
 - instantaneous: I1, I2, I3, In
 - maximum average: I1, I2, I3, In
- Voltages & frequency
 - instantaneous: V1, V2, V3, U12, U23, U31, F
- Powers
 - instantaneous: 3P, ΣP, 3Q, ΣQ, 3S, ΣS
 - maximum average: ΣP, ΣQ, ΣS
- Power factors
 - instantaneous: 3PF, ΣPF

Metering

- Active energy: +/- kWh
- Reactive energy: +/- kvarh
- Hours: ⌚

Harmonic analysis

- Total harmonic distortion (rank 51)
 - Currents: thd I1, thd I2, thd I3
 - Phase-to-neutral voltage: thd V1, thd V2, thd V3
 - Phase-to-phase voltage: thd U12, thd U23, thd U31

Events

Alarms on all electrical parameters

Communications ⁽¹⁾

RS485 with MODBUS protocol

Output

- Equipment control
- Alarm report
- Pulse report

Input

- Information report from a dry external contact

(1) Available as an option (see the following pages).

Front panel



1. Backlit LCD display
2. Pushbutton for currents (instantaneous and maximum), THD currents and the connection correction function.
3. Pushbutton for voltages, frequency and THD voltages.
4. Pushbutton for power (instantaneous and maximum), active, reactive and effective, power factor.
5. Pushbutton for energy sources and timer counter.

Case

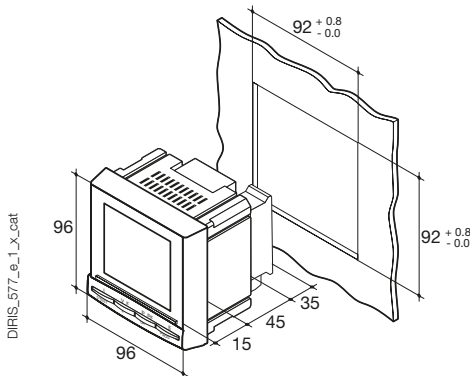

Type	Plug-in
Dimensions W x H x D	96 x 96 x 60 mm
Case degree of protection	IP30
Front degree of protection	IP52
Display type	Backlit LCD
Type of terminal strips	Fixed or removable
Section for connection of voltages and other terminals	0.2 ... 2.5 mm ²
Section for connection of currents	0.5 ... 6 mm ²
Weight	400 g

Plug-in optional modules

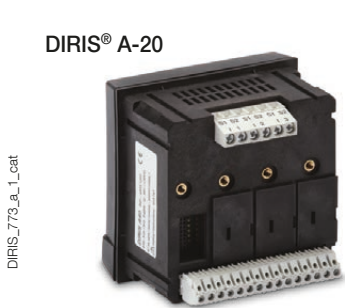

1 output

- 1 output that can be configured for:
- pulses: configurable (type, weight, duration) to kWh or kVarh.
 - Monitoring: 3I, In, 3V, 3U, F, ΣP, ΣQ, ΣS, ΣPFL/C, THD 3I, THD 3V, THD 3U and timer meter.
 - Equipment control



Communication

RS485 link with MODBUS protocol (speed up to 38 400 baud).



3 inputs , 1 output

- 3 inputs can be configured into:
- Information report from an external contact.
- 1 output that can be configured for:
- pulses: configurable (type, weight, duration) to kWh or kVarh.
 - Monitoring: 3I, In, 3V, 3U, F, ΣP, ΣQ, ΣS, ΣPFL/C, THD 3I, THD 3V, THD 3U and timer meter.
 - Equipment control

Accessories

Current transformer

See "Current transformers" pages.

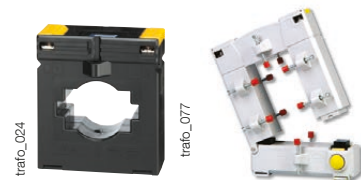

IP65 protection



DIRIS A-20

Multifunction measuring unit - PMD

measurement and monitoring - door mounting

Electrical characteristics

Current measurement (TRMS)	
Via CT primary	9 999 A
Via CT secondary	5 A
Measurement range	0 ... 11 kA
Input consumption	0.6 VA
Measurement updating period	1 s
Accuracy	0.2%
Permanent overload	6 A
Intermittent overload	10 I _n over 1 sec
Voltage measurements (TRMS)	
Direct measurement between phases	50 ... 500 VAC
Direct measurement between phase and neutral	28 ... 289 VAC
Input consumption	≤ 0.1 VA
Measurement updating period	1 s
Accuracy	0.2%
Power measurement	
Measurement updating period	1 s
Accuracy	0.5%
Power factor measurement	
Measurement updating period	1 s
Accuracy	0.5%
Frequency measurement	
Measurement range	45 ... 65 Hz
Measurement updating period	1 s
Accuracy	0.1%

Energy accuracy	
Active (according to IEC 62053-22)	Class 0.5 S
Reactive (in acc. with CEI 62053-23)	Class 2
Auxiliary power supply	
Alternative voltage	110 ... 400 VAC
AC tolerance	± 10%
DC voltage	120 ... 289 VDC
DC tolerance	± 20%
Frequency	50 / 60 Hz
Power consumption	10 VA
Pulse or alarm output	
Number	1
Type	100 VDC - 0,5 A - 10 VA
Max. number of manoeuvres	≤ 10 ⁸
Inputs	
Number	3
Power supply	10 ... 30 VDC
Minimum width of signal	10 ms
Minimum length between 2 pulses	18 ms
Type	Optical couplers
Communication	
Link	RS485
Type	2 to 3 half duplex wires
Protocol	MODBUS® in RTU mode
MODBUS® speed	1400 ... 38400 baud
Operating conditions	
Operating temperature range	- 10 ... + 55°C
Storage temperature	- 20 ... + 85°C
Relative humidity	95%

Terminals

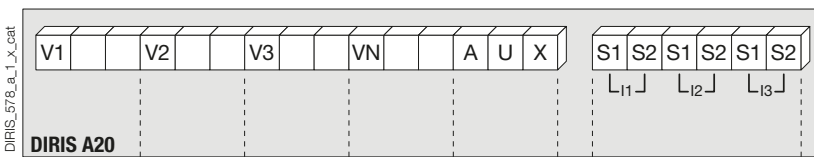

S1 - S2: current inputs.

AUX: auxiliary power supply U_s.
V1, V2, V3 & VN: voltage inputs.

Module communication

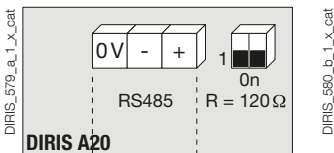

RS485 link.
R = 120 Ω : internal resistance for the RS485 link.

Output or alarm module

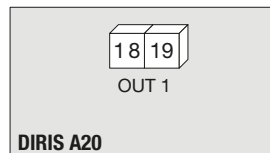

18 - 19: output n°1

Module with 3 inputs, 1 output

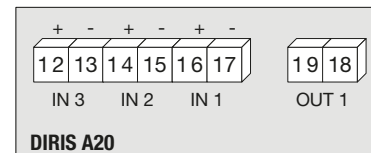

Connection

Low voltage balanced network

Recommendation

- For IT earthing systems, it is recommended that the CT secondary is not connected to earth.
- When disconnecting the DIRIS, the secondary of each current transformer must be short-circuited. This operation can be carried out automatically by a SOCOMEC PTI, which can be found in the SOCOMEC catalogue: please consult us.

3/4 wires with 1 CT

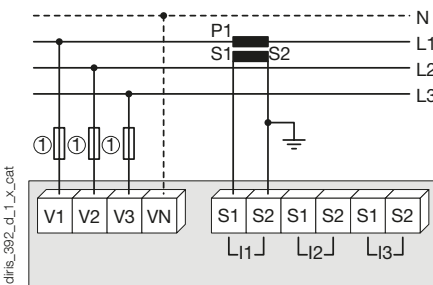

The 1CT solution reduces by 0.5% the accuracy of the phase for which the current is deduced by a vector calculation.
1. 0.5 A gG / 0.5 A class CC fuses.

Single-phase

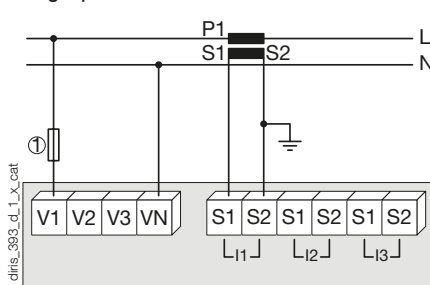

1. 0.5 A gG / 0.5 A class CC fuses.

Two-phase

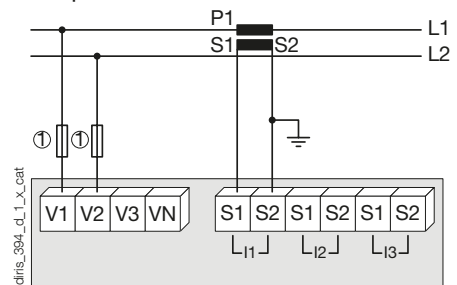

1. 0.5 A gG / 0.5 A class CC fuses.

Low voltage unbalanced network

3/4 wires with 3 CTs

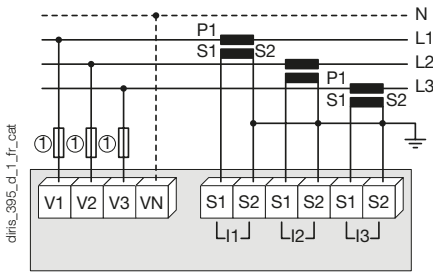

1. 0.5 A gG / 0.5 A class CC fuses.

3 wires with 2 CTs

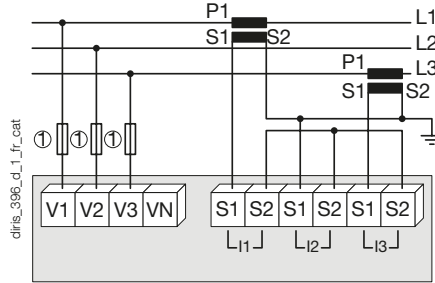

The 2CT solution reduces by 0.5% the accuracy of the phase for which the current is deduced by a vector calculation.
1. 0.5 A gG / 0.5 A class CC fuses.

3 wires with 2 CTs

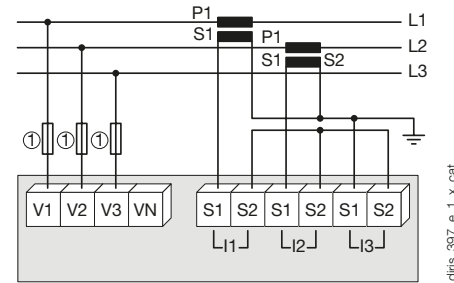

The 2CT solution reduces by 0.5% the accuracy of the phase for which the current is deduced by a vector calculation.
1. 0.5 A gG / 0.5 A class CC fuses.

Additional information

Communication via RS485 link

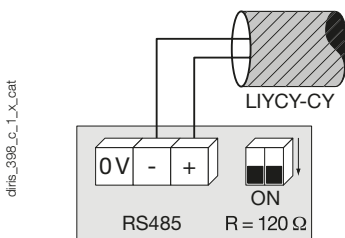

AC and DC auxiliary power supply

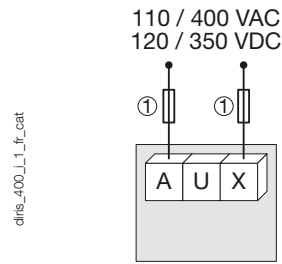

1. 0.5 A gG / 0.5 A class CC fuses.

References

Basic device		DIRIS A-20
Auxiliary power supply U_s		Reference
110 ... 400 VAC / 120 ... 350 VDC		4825 0402
Options		
Plug-in modules		Reference
On/Off output.		4825 0080
RS485 MODBUS® communication		4825 0082
3 inputs, 1 output		4825 0083
Accessoires	To be ordered in multiples of	Reference
Protection IP65	1	4825 0089
Plug-in kit for cutout 144 x 96 mm	1	4825 0088
3-pole fuse disconnect switches to protect input voltages (RM type)	4	5601 0018
1-pole + neutral fuse disconnect switches to protect the auxiliary supply (RM type)	6	5601 0017
gG 10x38 0.5 A fuses	10	6012 0000
Ferrite for use with communication modules	1	4899 0011
Current transformer range	1	See "Current transformers" pages.
Software associated with DIRIS		See "Easy Config System" pages
Automatic CT short-circuiting device		See "Current transformers" pages.

Expert Services

- > Study, definition, advice, implementation, maintenance and training... Our experts "Expert Services" offer complete support for the success of your project.

